



Tubular combined wall systems





Cover:
Neherkade, the Netherlands

Contents:
Aqaba, Jordan

Contents

04	Introduction
08	Definition
15	Design
20	Corrosion
26	Optimization
27	Installation guide
33	Anchoring system
37	Services

Introduction

ArcelorMittal

ArcelorMittal is the world's leading steel and mining company, present in more than 60 countries. It has led the consolidation of the world steel industry and today ranks as the only truly global steelmaker. ArcelorMittal is the leader in all major global markets, including automotive, construction, household appliances and packaging.

The Group leads in R&D and technology, holds sizeable captive supplies of raw materials and operates extensive distribution networks.

Its global industrial presence gives the Group exposure to all the key steel markets, from emerging to mature.

Projects

ArcelorMittal Projects, which is part of Long Carbon Europe, aims to provide the best and most cost efficient steel solutions. A continuous involvement throughout the project is therefore essential, from an advising role towards the investor in the early stages to a close follow-up during the construction phase.

The Projects organization consists of two main divisions: Foundation Solutions and Energy Projects. Foundation Solutions is the exclusive sales organization for steel foundation solutions with unique assets and broad experience from all over the world.

Energy Projects is ArcelorMittal's dedicated and specialized global organization for the supply of complete and customized steel solutions for the highly demanding international Oil & Gas sector.

Tube stockyard and production facilities in Dintelmond (The Netherlands)



Foundation Solutions

ArcelorMittal Projects Foundation Solutions offers total tailor-made solutions for the construction of quay walls, harbours, locks, breakwaters and embankments of rivers and canals. Other applications involve the protection of underwater or land excavations, excavation works for bridge abutments, retaining walls and underground car parks amongst others.

ArcelorMittal is the worldwide leader in the production of steel sheet piles with ArcelorMittal Projects as its exclusive sales organization. We are also specialized in the production and supply of foundation tubes as well as the design of steel structures. Foundation Solutions focuses on all steps in the process: starting from general support to the client, through the actual engineering, to the complete delivery of products on site ready for installation. With the possibility to produce tubes we provide a unique product in the world that can be used for many applications.

Besides the fabrication of new tubes, our presence with stock material of tubes, sheet piles and H-bearing piles all over the world, gives us the possibility to supply material quickly and allows us to offer tailor-made solutions.

Our complete range of products includes hot rolled and cold formed sheet piles, foundation tubes, but also includes H-profiles anchors, reinforcement bars and auger piles. In combination with our own port facilities, it allows us easy and economical logistics of the total package to the job site anywhere in the world.



Advantages spirally welded tubes

In general, foundation tubes belong to the welded steel tubes category. In this category two manufacturing processes can be distinguished;

- 1. Longitudinally welded: Longitudinal Submerged Arc Welding (LSAW).** Tubes produced with this method have one or two longitudinal seams formed by automatic submerged arc welding. At least one pass must be made on the inside and on the outside.
- 2. Spirally welded: Spiral Submerged Arc Welding (SSAW).** Tubes produced with this method have a spiral seam over the entire length of the tube.

Considering our foundation purposes, the method for making spirally welded tubes has advantages over longitudinally welded tubes:

- SSAW is a continuous process, compared to LSAW which is a discontinuous process. The length of longitudinally welded tubes is limited, so when longer tubes are required, more circumferential welds are needed and thus leading to higher costs.
- The machine to make spiral welded tubes is adjustable, so a wide range of diameters can be produced from a base material of constant width.

Foundation Solutions has a network of spiral mills at its disposal which are fully dedicated for the fabrication of foundation piles. All these production facilities are equipped with fully automated interlock welding machines and coating facilities.

Additionally they are located at deep water and fully equipped with heavy cranes so that piles can be produced to full lengths, coated, handled and transported.

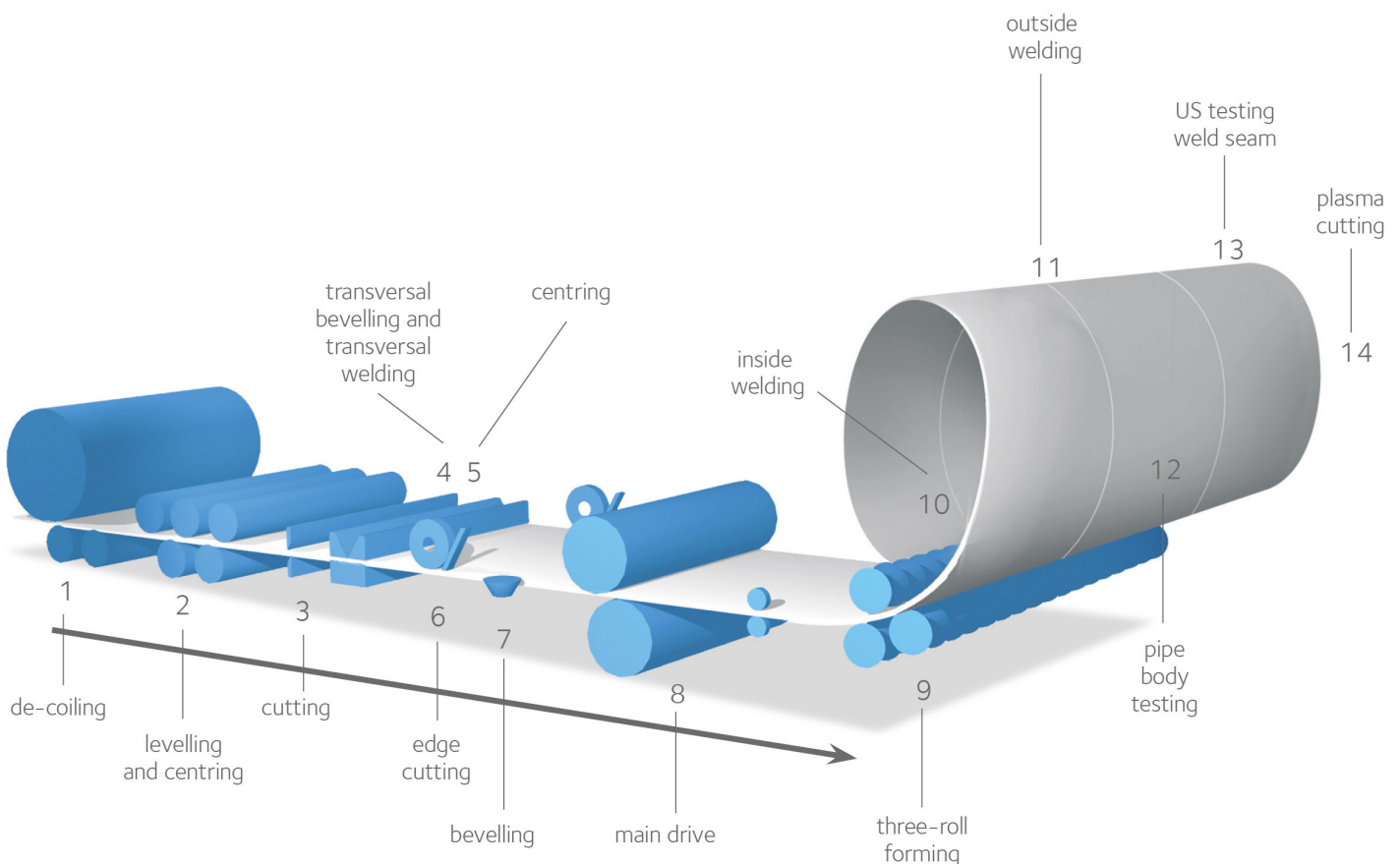

Production process of spirally welded pipes

Designing the tubular combined walls of the future

As vessels increase in size for more economical transport of containers and bulk cargo, the depth of major ports also increases over time. This increase leads to higher demands for the heavy-load berthing facilities. An optimal solution in this case is to replace the existing structure by a (stronger) combined wall solution.

For berthing structures in seaports, a tubular combined wall is an already proven, accepted and one of the most commonly used solutions all over the world. In the last few decades new developments have taken place to improve the capacity of tubular combined walls; increasing the steel strengths and improving the corrosion resistance.

The latest innovations in sheet piles have contributed to the design of wider combined wall systems that enable more cost-efficient retaining structures. Below a short summary of developments is given:

- AZ-800 (wider and more economical Z sections)
- Coils thickness increase from 25.4mm to 30mm
- Evolved understanding of local buckling phenomena leading to more economical design rules for tubes
- AMLoCor™ (more corrosion resistant steel)

These developments are meeting the increasing requirements for the application of retaining structures. Alongside the development needed to meet the rising performance standards, Foundation Solutions invests in providing its clients with cost-effective solutions, taking into consideration the latest possibilities and developments in the market.

In a business environment where products need to be adapted to local standards it is our philosophy to make improvements involving all stakeholders. While in continuous contact with universities and standardization committees, our team of engineers optimize designs into the best economical solutions together with engineering companies and contractors.

Foundation Solutions continues developing the products, always looking for more economical solutions for the benefit of the client. With the ever increasing demand of port facilities, Foundation Solutions is bringing the design of tubular combined walls to the next level to enable our clients to cope with the changing requirements of the berthing structures.

Keeping quay in operation during extension (Burchardkai, Germany)

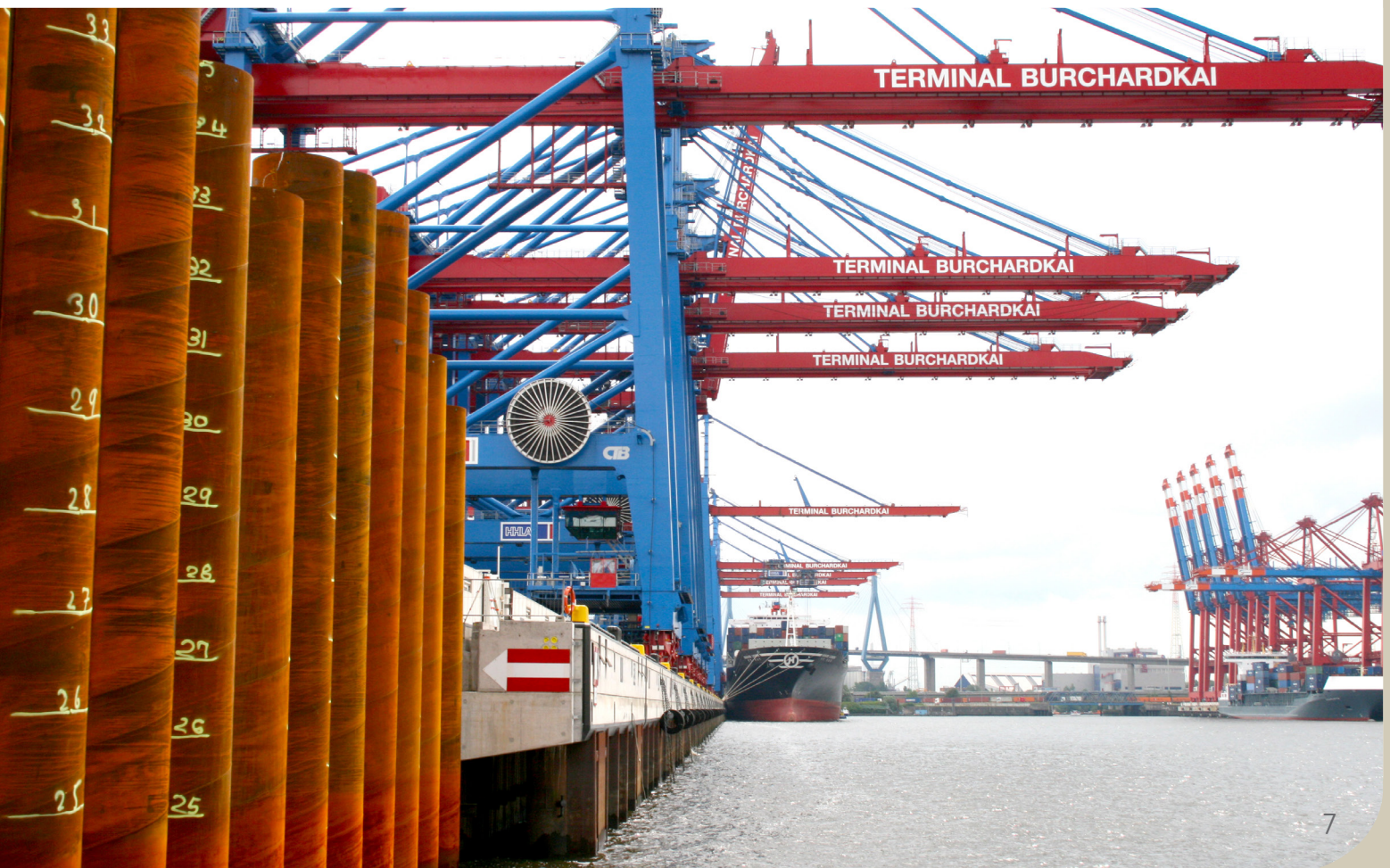

Definition

Principle of tubular combined walls (TCW)

For the design of steel retaining walls, three categories can be distinguished:

- **Sheet pile wall.** A wall consisting of only sheet piles is possible for small retaining heights and low occurring bending moments.
- **Combined wall.** When larger retaining heights and higher loads need to be considered, a homogeneous sheet pile wall is not sufficient anymore. In this case a combination of king piles and intermediate sheet piles is advisable due to its higher strength and stiffness. The king pile can either be a tube (Tubular Combined Wall) or an HZM beam.
- **Tubular wall.** When the necessary strength and stiffness cannot be achieved by the tubular combined wall, the tubular wall is the recommended solution.

The focus in this brochure is on tubular combined walls. This wall is composed out of the following three elements:

1. Tubes as king piles
2. Intermediate sheet piles
3. Interlocks (C6 or C9)

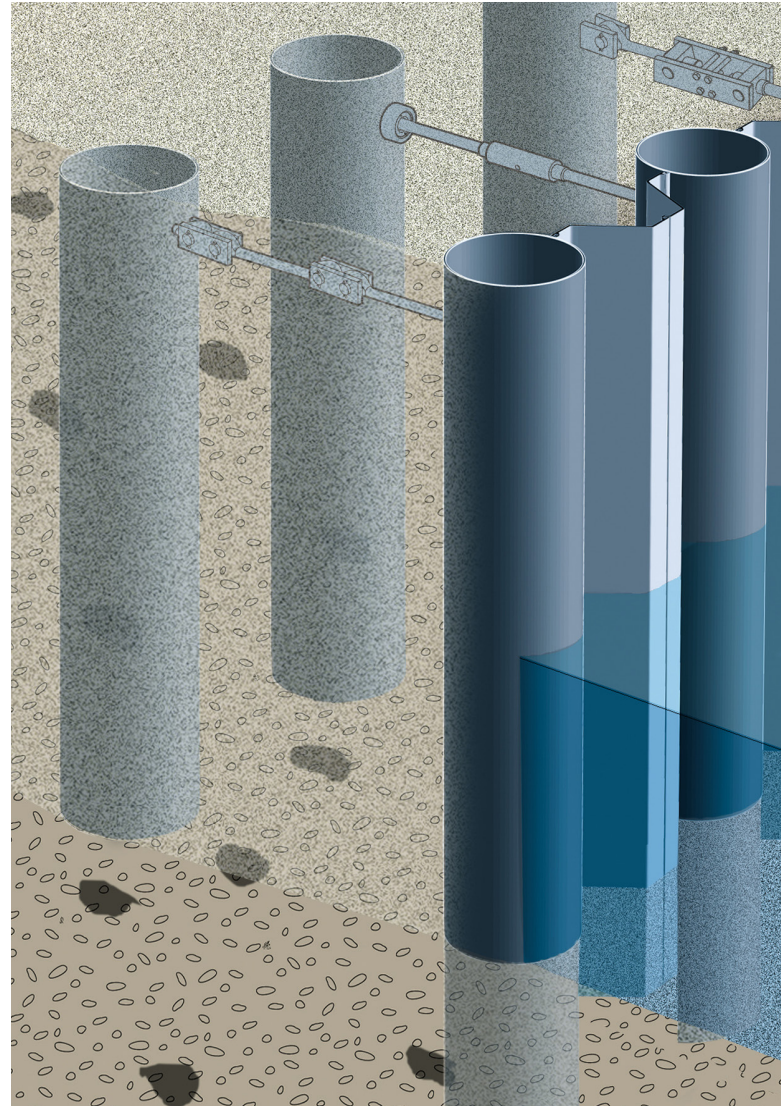

Tubular combined wall as retaining wall

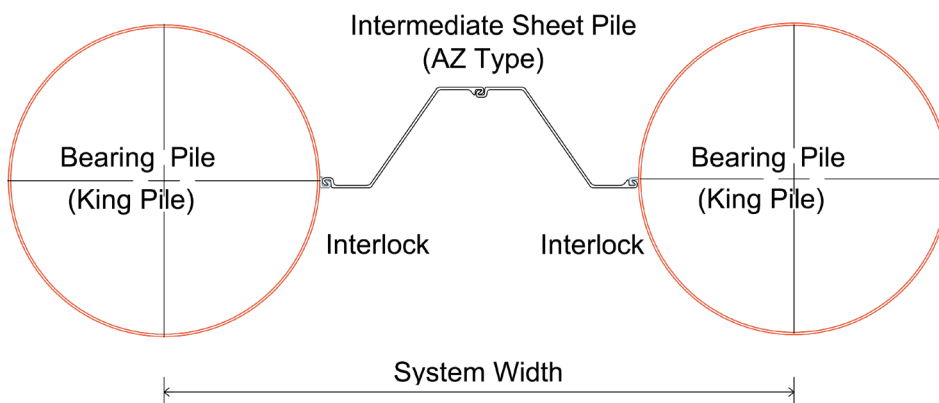

Tubular combined wall system with the different elements

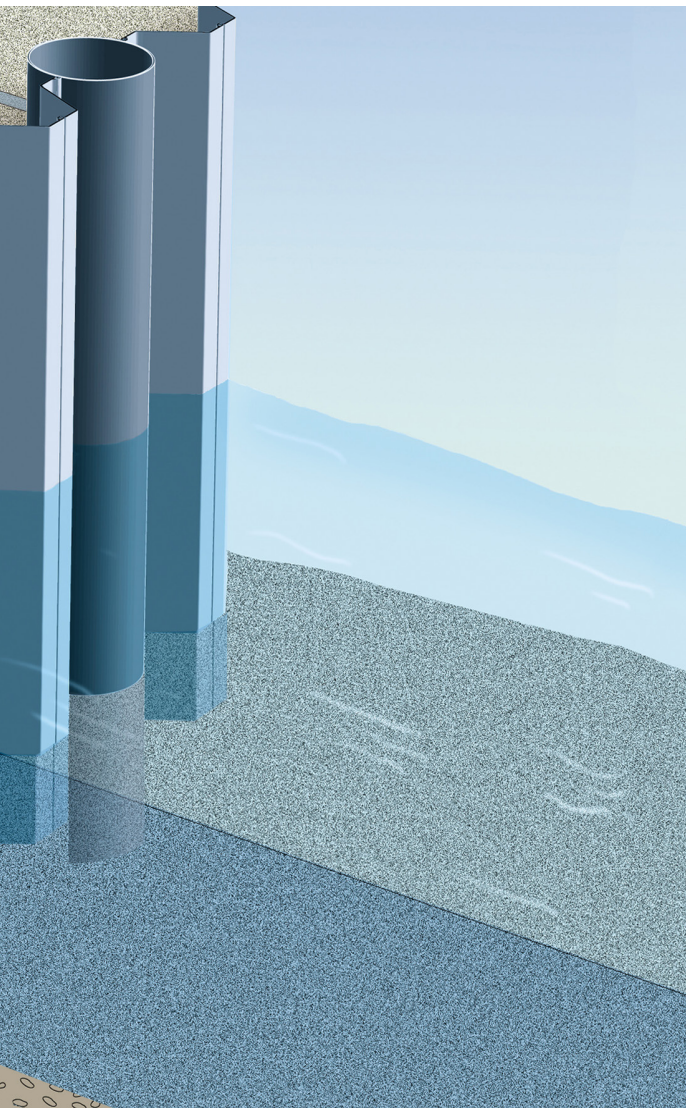

Advantages of tubular combined wall system

- Proven concept, numerous examples worldwide
 - quay walls in harbors all over the world
 - anchor wall for quay walls
 - onshore, nearshore and offshore breakwaters
 - soil retaining wall in locks, underground car parks, etc.
 - stabilizing wall in deep building pits
 - bridge abutments
- Very flexible solution:
 - numerous possibilities in diameter and wall thickness
 - flexibility in intermediate SSP (double/triple sheet piles possible)
 - always an alternative to be found
- Wide range of stiffness and strength parameters
- Economic solution with regards to weight and unit price
- Local sources possible
- Delivery from stock possible

Arch effect

The design of a combined wall is based on the principle that the retained soil behaves as an arch. In the figure on the right, the arch effect of a tubular combined wall is symbolized.

The soil pressure is transferred to the stiffest elements, in this case the tubes, while the water pressure affects both tubes and sheet piles. The intermediate sheet piles function as a membrane keeping the structure soil tight, while transferring the loads from the soil to the tubes and resisting the occurring water pressures.

To maintain the arch effect, it is important that the radius of the tube is larger than the height of the intermediate sheet piles. The larger the diameter of the tubes, the wider the intermediate sheet piles could be dimensioned while guaranteeing the arch effect of the soil.

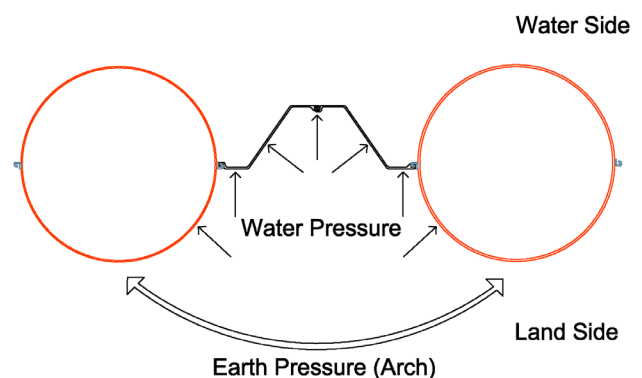

Arch effect of tubular combined wall

Elements of tubular combined wall

Tubes as king piles

The tubular piles fulfill two different structural functions in a tubular combined wall:

- Retaining component for soil and hydrostatic pressures
- Bearing piles for vertical loads

The tubes are often chosen for their flexural strength, stiffness and axial bearing capacity. An increase in retaining height results in a higher occurring bending moment, so a higher stiffness is needed to assure the same allowable displacement.

Technical delivery conditions

Pipes for construction purposes are normally produced according to EN 10219 or API 5L -PSL1. The EN 10219 is a European standard giving technical delivery conditions for cold formed, welded pipes for construction works. The API 5L is drawn by the American Petroleum Institute in order to provide standards for pipes suitable for transferring gas, water and oil.

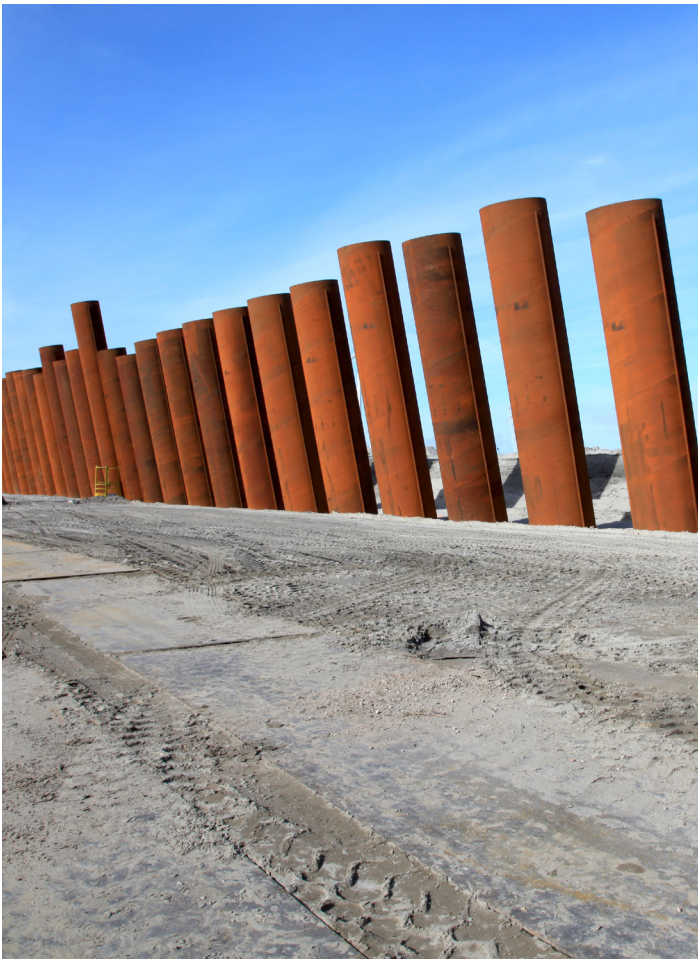

Project Wilhelminahaven, the Netherlands

Steel grades

Steel grades are built up by symbols and numbers showing the requested properties of the steel.

- An example of a steel grade according to EN 10219: S355J0H or S460MH

EN 10219: European production standard for cold formed tubes

S: structural steel

355: minimum yield strength [N/mm²]

J0: minimum impact energy value of 27 J at 0°C for Charpy testing, others are: JR (27 J at 20°C) and J2 (27 J at -20°C)

N or M: normalised rolling or thermomechanical rolling of the feedstock material (coils). Both are rolling processes in which the final deformation is carried out in a certain temperature range. When a minimum impact energy value is specified at a temperature of -50°C, the letter L is added to N or M.

H: hollow sections

- An example of a steel grade according to API 5L-PSL1: X52

API 5L: Production standard of line pipe of the American Petroleum Institute

PSL1: Product Specification Level 1

52: 52000 pounds per square inch = 360 N/mm². This is the yield strength

Mechanical properties

Steel grade according to EN 10219-1	Minimum yield strength R_{eH} (T≤16mm) ¹ N/mm ²	Minimum yield strength R_{eH} (1 T≤40mm) ¹ N/mm ²	Minimum tensile strength R_m (3≤T≤40mm) ¹ N/mm ²	Minimum elongation (T≤40mm) ¹ %
S235JRH	235	225	340-470	24
S275J0H/J2H	275	265	410-560	20
S355J0H/J2H	355	345	490-630	20
S420MH	420	400	500-660	19
S460MH	460	440	530-720	17

Steel grade according to API 5L, PSL1	Minimum yield strength R_{eH} N/mm ²	Minimum tensile strength R_m N/mm ²	Minimum elongation ² %
B	245	415	23
X42	290	415	23
X46	320	435	22
X52	360	460	21
X56	390	490	19
X60	415	520	18
X65	450	535	18
X70	485	570	17

¹ T: Thickness

² Depends on tensile test piece cross-sectional area

Chemical properties

Steel grade according to EN 10219-1	Mass percentage						CEV max. (T≤40mm)
	C max.	Mn max.	P max.	S max.	Si max.	N max.	
S235JRH	0.17	1.40	0.045	0.045	-	0.009	0.35
S275J0H/J2H	0.20	1.50	0.040	0.040	-	0.009	0.40
S355J0H/J2H	0.22	1.60	0.040	0.040	0.55	0.009	0.45
S420MH	0.16	1.70	0.035	0.030	0.50	0.020	0.43
S460MH	0.16	1.70	0.035	0.030	0.60	0.025	-

Steel grade according to API 5L, PSL1	Mass percentage					Ti+V+Nb max.
	C ¹ max.	Mn ¹ max.	P max.	S max.		
B	0.26	1.20	0.030	0.030		0.15 ²
X42	0.26	1.30	0.030	0.030		0.15
X46	0.26	1.40	0.030	0.030		0.15
X52	0.26	1.40	0.030	0.030		0.15
X56	0.26	1.40	0.030	0.030		0.15
X60	0.26 ³	1.40 ³	0.030	0.030		0.15 ³
X65	0.26 ³	1.45 ³	0.030	0.030		0.15 ³
X70	0.26 ³	1.65 ³	0.030	0.030		0.15 ³

¹ According to API 5L: For each reduction of 0.01% below the specified maximum carbon content, an increase of 0.05% above the specified maximum manganese content is permissible, up to a maximum of 1.50% for grade X42 to X52, 1.65% for X56 to X65 and 2.00% for X70.

² Unless otherwise agreed, the sum of the niobium and vanadium contents shall be ≤ 0.06 %.

³ Unless otherwise agreed.

Geometric tolerances

Standard	Outside diameter D	Wall thickness T	Straightness	Out-of-roundness	Mass	Maximum weld bead height ¹
EN 10219-2	+/- 1% max. +/- 10.0 mm	+/- 10% max. +/- 2.0 mm	0.20% of total length	+/- 2%	+/- 6%	T ≤ 14.2 mm: 3.5 mm T > 14.2 mm: 4.8 mm

¹ Tolerance on height of internal and external weld bead for submerged arc welded hollow sections.

More information can be found in the brochure 'Spirally Welded Steel Pipes'.

Interlocks

To connect the intermediate sheet piles to the tubes, interlocks are welded on the tube. This allows the tubular combined wall to act as a solid continuous system.

For a tubular combined wall a C6 or C9 interlock can be applied. The advantage of a C6 interlock is that it is easy to weld on the tube. Furthermore, the C6 interlock weighs 6 kg/m, compared to the 9 kg/m for the C9 interlock, which makes the C6 more economical. The C9 has the advantage of a fixed and guaranteed interlock opening.



Interlock types

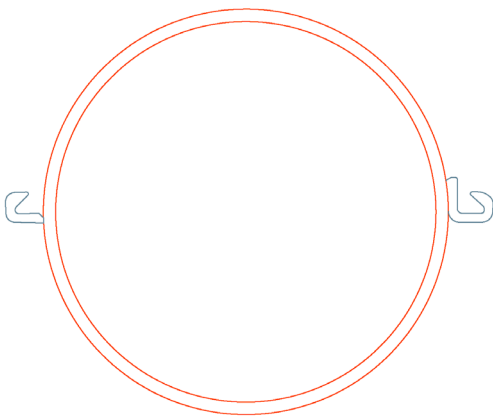

Connection of interlocks and tube

Intermediate sheet piles

ArcelorMittal is the world leader in production of hot rolled steel sheet piles. We have the largest range of possible intermediate sheet piles, leading to the most optimal solutions for combined wall systems.

The sheet piles in a tubular combined wall keep the structure soil tight and resist the occurring water pressures. The sheet piles themselves can withstand very high water pressures. This was tested in cooperation with the Liege University's Structural Steelwork Department, where a rubber air bag was used to exert the loading as realistically as possible.

In some occasions even a water column of 40 meters was resisted by the sheet piles. It will have some plastic deformation under high pressures in the corners B and F (see picture below), but not in the interlocks. The sheet pile profile gradually tends towards a circular arc but its function remains intact. More information can be found in the brochure "[AZ Sheet Pile In Combined Walls](#)".

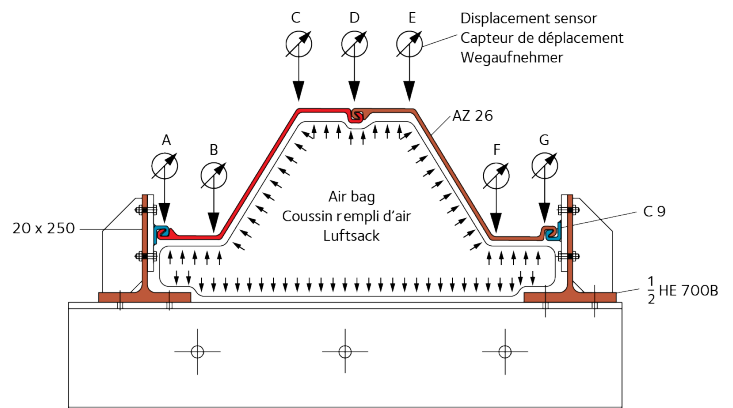

Resistance of sheet piles against high water pressures

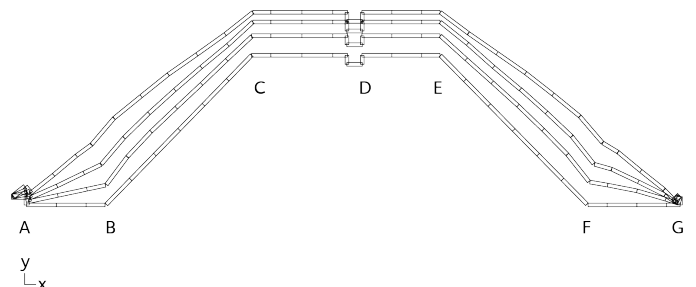

Plastic deformation of sheet piles

Tubular wall

Our wide product range results in many possibilities for intermediate sheet piles which can be used in tubular combined walls, from a pair of AZ-piles towards a pair of or triple U-piles. More information about the production range can be found in the 'General Catalogue'.

The intermediate sheet piles are usually partially crimped for installation purposes. Sheet piles longer than 10m get 3 triple crimping points, sheet piles shorter than 10m get 2 triple crimping points, see below figure for an example with AZ type sheet piles.

Since the crimping points are only at the top, the intermediate sheet piles have a greater flexibility. This is convenient because the tubes are not always placed perfectly vertical. The AZ sheet piles can be squeezed closer together or further apart, without tearing of the sheet pile or the interlocks.

When selecting the type of sheet pile the drivability should be taken into account. The longer the intermediate sheet piles, the heavier the section needs to be. For example, when the length of the sheet piles exceeds 20 meters it is advised to use a stronger section like the AZ 25-800.

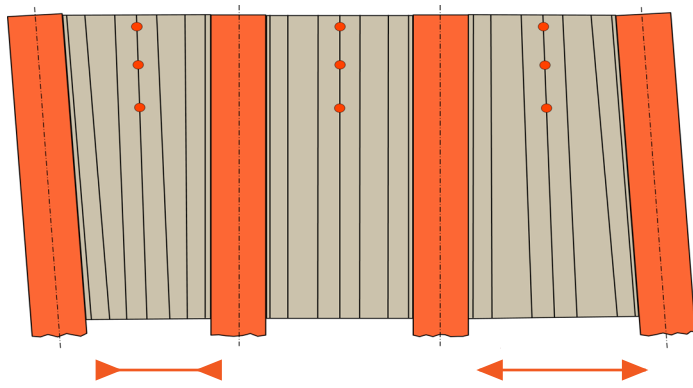

Partial crimping

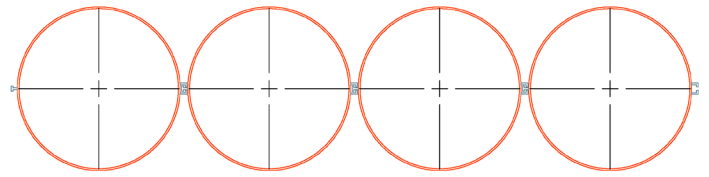

A tubular wall system with LT interlocks

For very high retaining heights, a tubular wall system can be an interesting solution. Compared to the tubular combined wall, the intermediate sheet piles are replaced by tubes to form a continuous tubular wall. This results in a solution with a higher stiffness and higher bending moment capacity. Since tubes are less flexible than intermediate sheet piles, higher forces can occur in the interlocks. This problem can be solved by paying special attention to the interlocks.

The C6 or C9 interlocks used in tubular combined walls are replaced by LT or BT interlock for tubular walls.



L sections of LT interlock



BT Interlock with rubber flaps for soil tightness

Design

Design input parameters

In order to make a reliable design, the engineers need to have sufficient and accurate information. In some cases, this information is not available and assumptions have to be made. In this section the most important design criteria and input parameters for the engineering part are discussed.

- **Soil conditions.** Key element in the geotechnical design is precise knowledge of the soil conditions. They are often difficult to predict and mistakes are easily made. Extensive field tests and laboratory tests are therefore needed in order to improve reliability of a proposed design. The more reliable and detailed the soil composition and parameters per soil layer are, the more accurate and economical the final design can be.
- **Retaining height.** This is known as the distance between the top of the wall and the bottom of the seabed level next to the wall. This is an important parameter as it indicates how much soil, rock and water need to be retained.
- **Water levels.** On both sides of the combined wall an indication of the occurring water levels is needed to assess the difference in water pressure. The extreme water levels which could occur during the design life are often governing. Take notice that alteration of the ground water table could occur during different construction phases.
- **Loads.** A retaining structure can be subject to different types of loads, both horizontal and vertical. Horizontal loads like bollards, fenders, anchor loads, etc. and vertical loads resulting from container cranes, capping beam, working loads, storage loads, etc. could occur. It is important that current and future loads acting on the structure are well known since they can have a major impact on the dimensioning of the tubular combined wall.

Having determined the environment in which the new structure needs to be designed, the requirements of the new structure need to be clearly defined with the client. The specifications of the intended ships berthing at the quay have an impact on the bollard and fender loads but will also influence the dredging depth and the surcharge load on the quay.

Other important design criteria are the predicted corrosion rates (or the protection against corrosion) and the different construction stages foreseen.



Parameters tube and tubular combined walls

As the tubes function as the bearing elements in the combined wall, they are generally longer than the intermediate sheet piles. In most cases, it is sufficient to install the tip of the sheet piles 3 to 5m below seabed level in order to prevent piping.

The following formulas give respectively the moment of inertia, the section modulus and the cross-sectional area of the tubular piles:

$$I_{Tube} = \frac{\pi \cdot (D^4 - (D - 2 \cdot t)^4)}{64}$$

$$W_{Tube} = \frac{I_{Tube}}{0,5 \cdot D}$$

$$A_{Tube} = \frac{\pi \cdot (D^2 - (D - 2 \cdot t)^2)}{4}$$

The design of a tubular combined wall is similar to designing a conventional sheet pile wall, although the section properties are determined differently. The following design formulas can be used for the design:

$$I_{TCW} = \frac{I_{Tube} + I_{SSP}}{B_{SYS}}$$

$$W_{TCW} = \frac{I_{TCW}}{0,5 \cdot D}$$

(if $0,5 \cdot D >$ height of SSP)

With:

I_{TCW}	Moment of inertia of combined wall	[cm ⁴ /m]
W_{TCW}	Section modulus of combined wall	[cm ³ /m]
I_{SSP}	Moment of inertia of sheet piles	[cm ⁴]
B_{SYS}	System width $D_{Tube} + B_{SSP} + 2 \times B_{Interlock}$	[m]
B_{SSP}	Width intermediate sheet piles	[m]
$B_{Interlock}$	Width interlocks (0.025m for C6, 0.030m for C9)	[m]

To calculate the weight of the tubes the following formula can be applied:

$$G_{Tube} = (D - t) \cdot t \cdot F$$

With:

G_{Tube}	Weight of the tube	[kg/m]
D	Diameter of the tube	[m]
t	Thickness of the tube	[m]
F	Factor for determining the weight of steel	24661,5

The weight of the TCW can be calculated as:

$$G_{TCW} = \frac{G_{Total}}{B_{SYS} \cdot L_{Tube}}$$

With:

G_{TCW}	Weight of combined wall	[kg/m ²]
G_{Total}	Weight of one system (= $G_{Tube} + G_{SSP} + G_{Interlock}$)	[kg]
L_{Tube}	Length of the tube	[m]

Steel stress verification

If one considers only the effect of the bending moment, steel stresses can be determined with the basic formula:

$$\sigma = \frac{M}{W_{TCW}}$$

In case of vertical loads the stress analysis should be expanded in order to include the vertical loads and additional bending moments induced by deflection and eccentricity:

$$\sigma = \frac{M}{W_{TCW}} + \frac{N \cdot e}{W_{TCW}} + \frac{N}{A_{Tube}}$$

With:

N	Vertical force	[kN]
e	Eccentricity	[m]
A_{Tube}	Sectional area of tube	[mm ²]
σ	Max. steel stress due to bending moment	[N/mm ²]
M	Bending moment	[kNm/m]

For both options as discussed above, the final stress verification has to be done according to the formula:

$$\sigma \leq f_y$$

f_y Yield strength according to the steel grade of bearing element in the tubular combined wall

Verification of intermediate SSP section

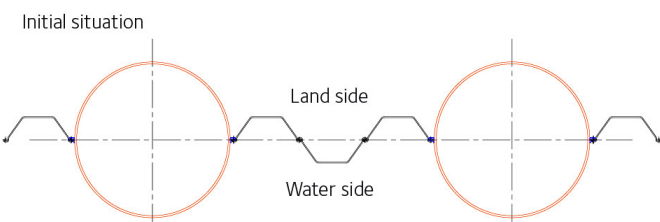

Verification intermediate sheet piles

Additional to the previous verification of the tubes, it is necessary to check if the intermediate sheet piles are capable of resisting the water pressure. In this case the sheet piles can be simplified as a beam, visualized in the picture below. The following formula can be used to determine the maximum bending moment capacity:

$$M_{s;d} \leq M_{r;d}$$

$$M_{s;d} = \frac{1}{16} \cdot q_d \cdot l^2 \leq W_{pl} \cdot f_{s;d} = M_{r;d}$$

With:

$M_{s;d}$	Occurring bending moment due to water pressure	[kNm/m]
q_d	Water pressure	[kN/m] ²
W_{pl}	Plastic section modulus intermediate sheet piles	[mm ³ /m]
$f_{s;d}$	Tensile strength of the steel grade	[N/mm ²]
$M_{r;d}$	Bending moment capacity intermediate sheet pile	[kNm/m]

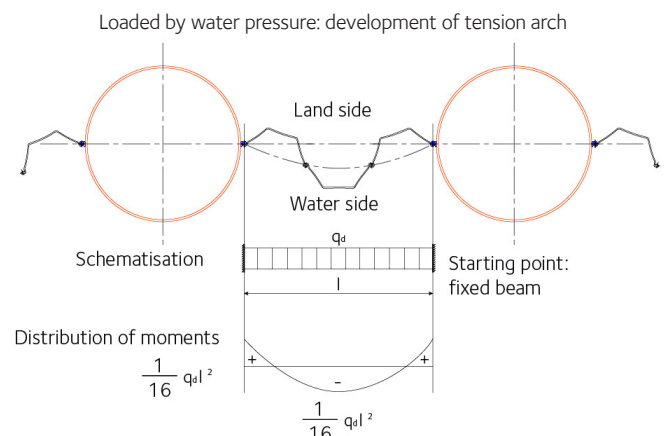

Vertical bearing capacity

Besides the steel stress verification of the tube, the vertical bearing capacity of the tube has to be checked.

The deadweight of the tube together with the expected vertical forces (like crane loads) need to be supported by the soil. The total vertical bearing capacity can be derived from the shaft friction and point resistance of the tube. This can be seen in the figure on the right.

The shaft friction increases with longer tubes and/or an increasing diameter. The point resistance increases when a footplate or a thicker end piece (ring) is attached to the bottom of the pile.

The total pile vertical bearing capacity is the sum of the shaft resistance and the point resistance which both depend on soil conditions and tube specifications.

In sandy soils, a beneficial plugging effect can occur at open ended tubes. Whether this plugging effect takes place depends on the diameter of the tube and has a significant impact on the total bearing capacity as a sand plug enhances the point resistance considerably.

The value of the bearing capacity can vary between 1,500 kN with no plug and 10,000 kN where a plug has formed. To allow plugging, the point resistance Q_p needs to have a lower value than the inside shaft friction of the tube. The density of the sand at the endpoint of the tube also affects the plugging effect.

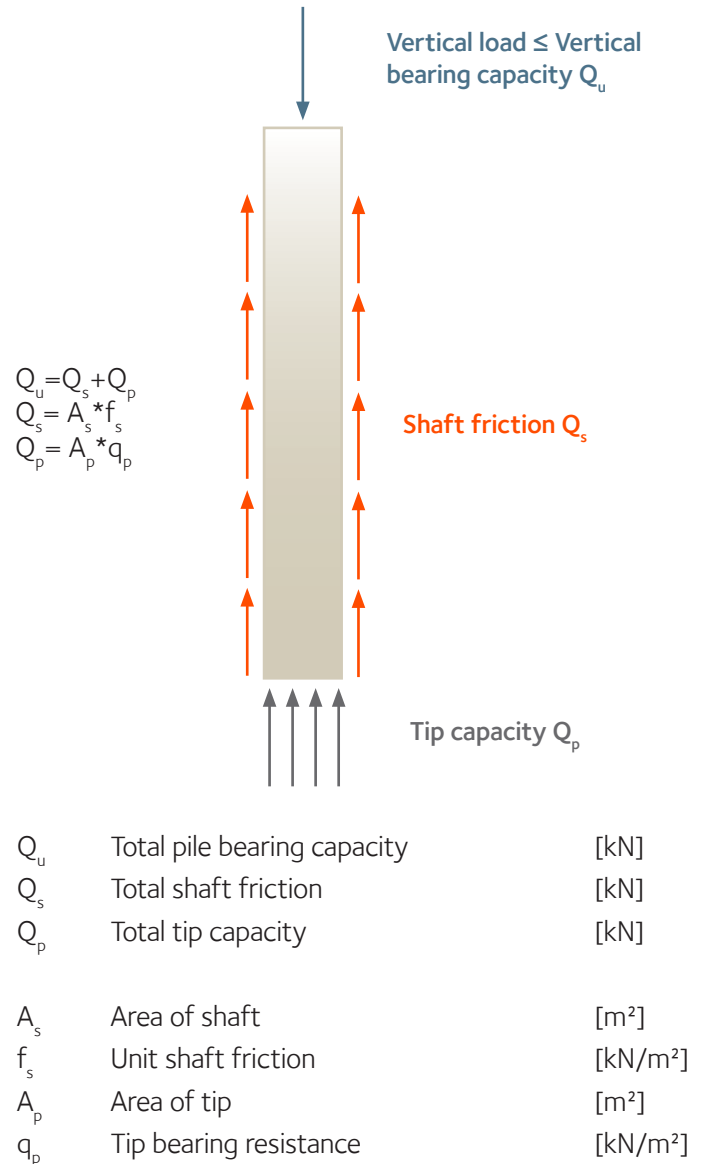

Local buckling considerations

In the search for the most economical solution the weight of the combined wall is often optimized. With respect to the limits for installation, the diameter of the tube tends to increase, while the wall thickness decreases. In other words, the diameter over thickness (D/t) ratio increases.

When tubular combined walls are designed with some corrosion allowance (sacrificial steel thickness), the D/t ratio of the tube at installation is different from the D/t ratio at the end of the design life. In that case the cross-sectional resistance needs to be evaluated at the end of the design life.

With increasing D/t ratio and steel grade the tubes become more susceptible to local buckling. Local buckling can be characterized as a sudden failure of a structural member subjected to high compressive stress. This failure can occur before the yield strength of the steel is reached.

To calculate the influence of local buckling, calculation methods according to the Eurocode EN1993-1-1 can be applied. In this code four different profile classifications are defined. Tubes with a high D/t ratio combined with high steel grade will be classified as class 4. When calculating the reduction of strength according to EN1993-1-6 for class 4 tubes, it leads to conservative and uneconomical designs. In order to get more insight in the local buckling phenomena several testing programs were executed.

The results from one of these programs is reported in the 'CUR211 - Handbook Quay Walls'. In this guideline an alternative method is proposed to calculate with class 4 tubes, leading to more economical but still safe solutions. If requested, the dedicated engineering department of Foundation Solutions can assist in the design calculations.

When comparing the approach from Handbook Quay Walls to the design approach according to the Eurocode, the remaining bending moment capacity of the tubes is much higher. There is also a distinction made between sand filled and empty tubes. The sand fill gives the tube more resistance to initial local buckling. It also prevents a sudden collapse of the piles after an initial local buckle.

Water tightness considerations

Depending on the application of the system, a certain degree of water tightness is required. When a water level is present on both sides of the wall, it is beneficial to minimize the water level difference between ground and sea water level.

This will lead to lower resulting water pressures acting on the wall and therefore a less heavy tubular combined wall. Especially in the case of a quay wall at locations with large tidal differences, high additional water pressures can occur. By installing weep holes in the intermediate sheet piles, the resulting water pressures will decrease to more acceptable levels.

In other occasions, like deep excavations, it is favorable to have low volumes of water entering the site through the tubular combined wall. The sheet piles and tubes are completely watertight, but water can still flow through the interlocks.

By installing a sealing system in the interlocks the flow of water through the tubular combined wall can be reduced. More information about sealing systems (e.g. AKILA®) can be found in our brochure "[Impervious Steel Sheet Pile Walls: Design And Practical Approach](#)".

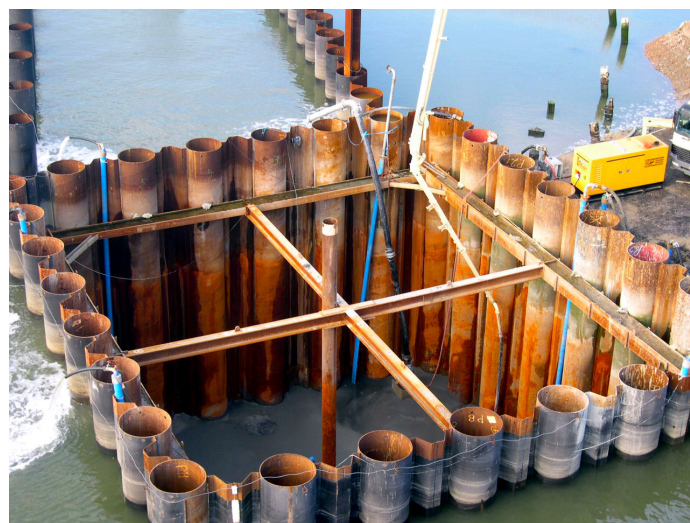

Watertight tubular combined wall Demey – Oostende (Belgium)

Corrosion

Corrosion impact

Corrosion is a natural process, which converts a refined metal to its natural form, in this case, steel to iron oxide. It is the gradual degradation of metals by chemical and/ or electrochemical reactions with their environment.

The chemical reaction that will occur for steel is described on the right for the most common form of corrosion. This type of corrosion is composed of 4 half-reactions, for which water is needed to start the process. When all the half reactions are summarized, water drops out from the equation, but its molecules have been used in various forms during the process.

When using steel as a construction material, it is important to evaluate the effect of corrosion over the required service life. In EN1993-5 indications are given to enable the engineer to determine how much corrosion has to be considered for tubes and sheet piles.

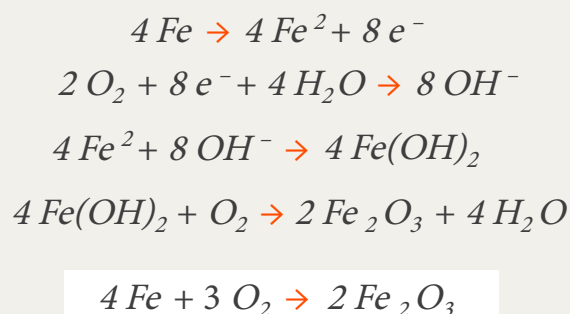

The corrosion rates are based on temperate environments typical of those found in countries involved in the drafting of the Eurocodes. Depending on the climate, temperature, salinity, humidity, etc. other values for corrosion rates can be found. A summary table can be found below.

Uniform corrosion rates for different conditions according to EN1993-5 in (mm)

Years	0	5	25	50	75	100
Atmospheric conditions						
Normal atmospheres	0.00	0.05	0.25	0.50	0.75	1.00
Locations close to the sea	0.00	0.10	0.50	1.00	1.50	2.00
Soil						
Undisturbed natural soils (sand, silt, clay, schist, ...)	0.00	0.00	0.30	0.60	0.90	1.20
Polluted natural soils and industrial grounds	0.00	0.15	0.75	1.50	2.25	3.00
Aggressive natural soils (swamp, marsh, peat, ...)	0.00	0.20	1.00	1.75	2.50	3.25
Non-compacted and non-aggressive fills (clay, schist, sand, silt, ...)	0.00	0.18	0.70	1.20	1.70	2.20
Non-compacted and aggressive fills (ashes, slag, ...)	0.00	0.50	2.00	3.25	4.50	5.75
Compacted and non-aggressive fills (clay, schist, sand, silt, ...)	0.00	0.09	0.35	0.60	0.85	1.10
Compacted and aggressive fills (ashes, slag, ...)	0.00	0.25	1.00	1.63	2.25	2.88
Water						
Common fresh water (river, ship, canal,...) in the zone of high water (water line)	0.00	0.15	0.55	0.90	1.15	1.40
Very polluted fresh water (sewage, industrial effluent,...) in the zone of high attack (water line)	0.00	0.30	1.30	2.30	3.30	4.30
Sea water in temperate climate in the zone of high attack (low water and splash zones)	0.00	0.55	1.90	3.75	5.60	7.50
Sea water in temperate climate in the zone of permanent immersion or in the intertidal zone	0.00	0.25	0.90	1.75	2.60	3.50

Besides the influence of the environment, marine corrosion rates are also dependent upon the exposure zone which is related to depth and tidal conditions. The splash and low water zone are more susceptible to corrosion (see picture below).

In other situations with almost no oxygen concentrations (below surface and water level) the corrosion over the lifetime will be low to negligible.

The high bending moments acting on the tubes are generally not at the same location as the highest corrosion rates. In the design, the strength of the tube should be checked for the governing loads over the length of the pile in accordance with the corresponding corrosion conditions.

Various protection methods exist that lower or mitigate corrosion issues. The measures most frequently applied are:

- Sacrificial steel thickness
- Usage of corrosion resisting steel
- Coating
- Cathodic protection
- Concrete capping beam

The application of protection can be determined once the envisioned service life is known. Depending on the local circumstances, it is possible to apply a combination of the measures above.

Foundation Solutions can provide thicker material (sacrificial steel thickness), corrosion resistant steel (AMLoCoR™) and/or specially coated products.

Different corrosion zones along the depth of retaining walls

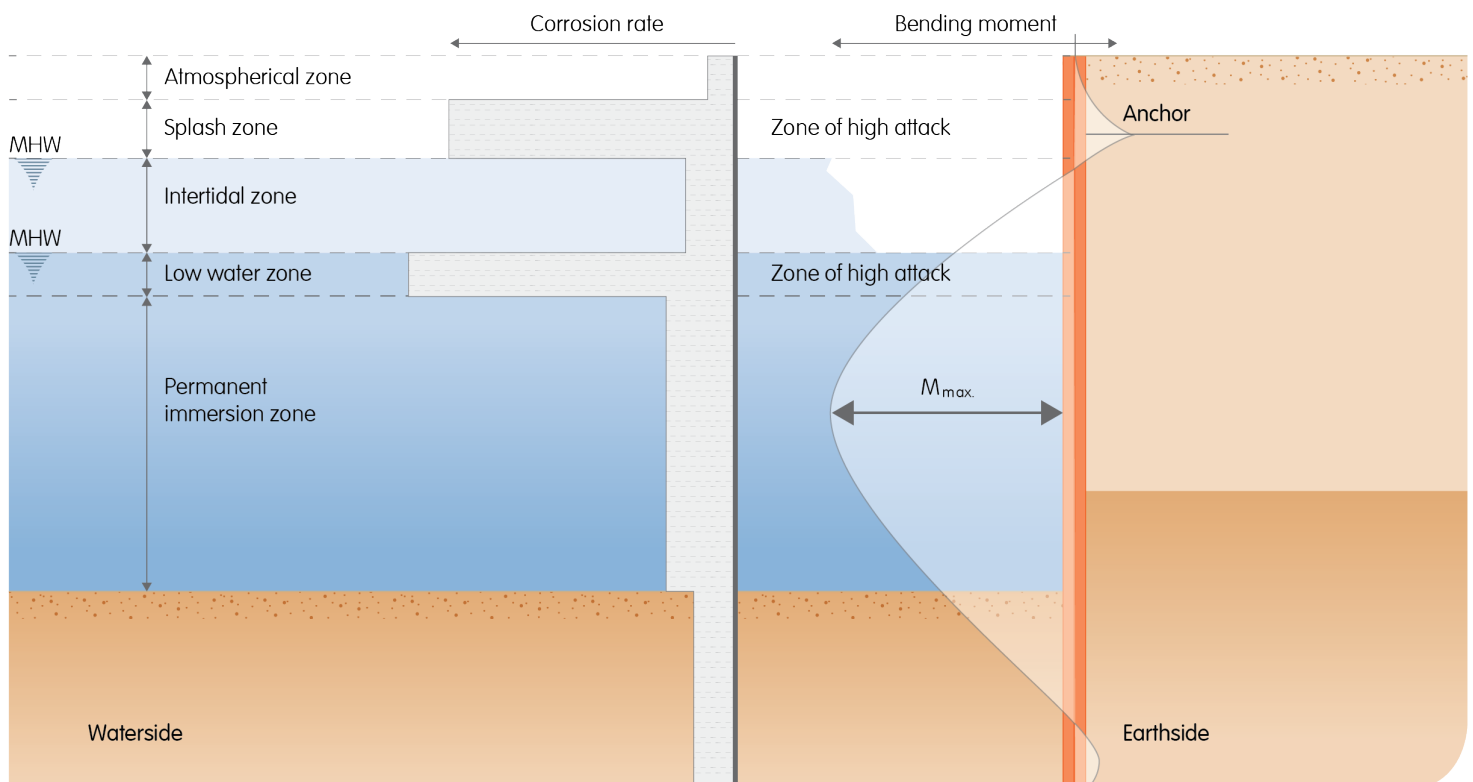

Sacrificial steel thickness

The environmental conditions at the front side of the quay wall are often different from the rear, which lead to different corrosion rates over the cross-section. By reducing the wall thickness with the expected corrosion the resulting tube dimensions can be obtained.

These dimensions are used to calculate the resulting tube's moment of inertia and bending moment capacity after corrosion. Foundation Solutions offers a free engineering service which can assist with precise calculations of the impact of asymmetric corrosion on the design.

It is part of our philosophy to provide integral solutions that enable our clients to use better engineered solutions in order to submit more competitive offers. Applying different corrosion rates over the cross-section results in a displacement of the neutral axis (from Y towards Y' in the figure below). By using Steiner's theorem, the reduced moment of inertia and bending moment capacity can be determined.

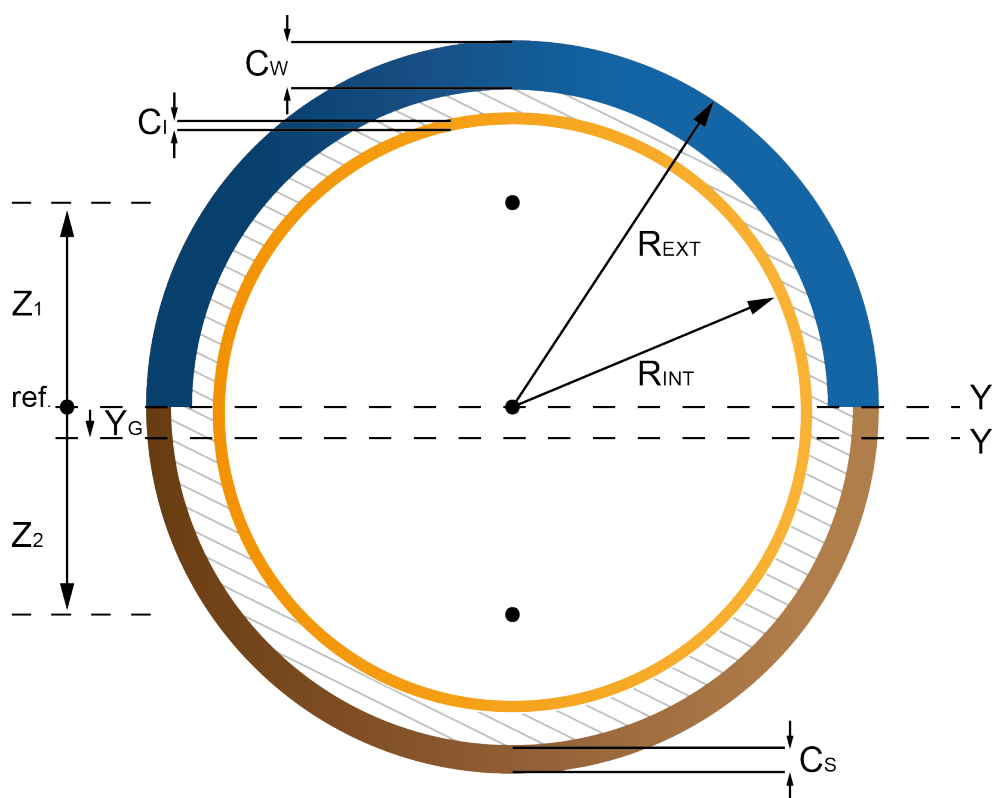

Figure: Tube surface with reduced area profile

C_W	=	Corrosion on waterside [mm]
C_S	=	Corrosion on soil-side [mm]
C_I	=	Internal corrosion [mm]
R_{INT}	=	Internal radius [mm]
R_{EXT}	=	External radius [mm]
Z_1	=	Distance from reference line to the center of mass of piece 1 [mm]
Z_2	=	Distance from reference line to the center of mass of piece 2 [mm]
Y_G	=	Distance from reference line to the new center of mass due to asymmetric corrosion [mm]

AMLoCor™

During the last 20 years, several steel grades have been tested in many laboratories and in various ports in order to develop a new steel grade that would be less prone to corrosion in a maritime environment.

Additionally, trials at the steel plant and rolling mill were done to optimize the production of a whole range of piling products in such specialized steel. The key challenge was to develop a steel that would perform better in the critical zones to which a typical maritime quay wall is exposed.

The result is AMLoCor™, the new 'Low Corrosion' steel grade developed by ArcelorMittal. The main advantage of AMLoCor™ is a significant reduction of the corrosion rates in both the Low Water Zone (factor 5) and in the Permanent Immersion Zone (factor 3).

In these two zones the bending moments are generally high (see figure below) and therefore often governing in the design. When the corrosion rates are lowered in these zones, less steel is required leading to a more economical structure.

Above the low water zone AMLoCor™ can be treated as normal carbon steel with regards to corrosion rates. In this zone the maintenance is more straightforward and conventional protection measures can still be used (e.g. coatings, concrete capping beams, etc.)

Although AMLoCor™ is a micro-alloyed steel, the mechanical properties are similar to structural carbon steel. Steel grades with yield strengths up to 485 MPa (X70) can already be achieved.

The first tubular combined wall in AMLoCor™ was installed in the Amazonehaven in the Port of Rotterdam. Here a 120m long quay wall was executed completely in AMLoCor™ (including interlocks).

Typical loss of steel in a marine environment of carbon steel and AMLoCor™

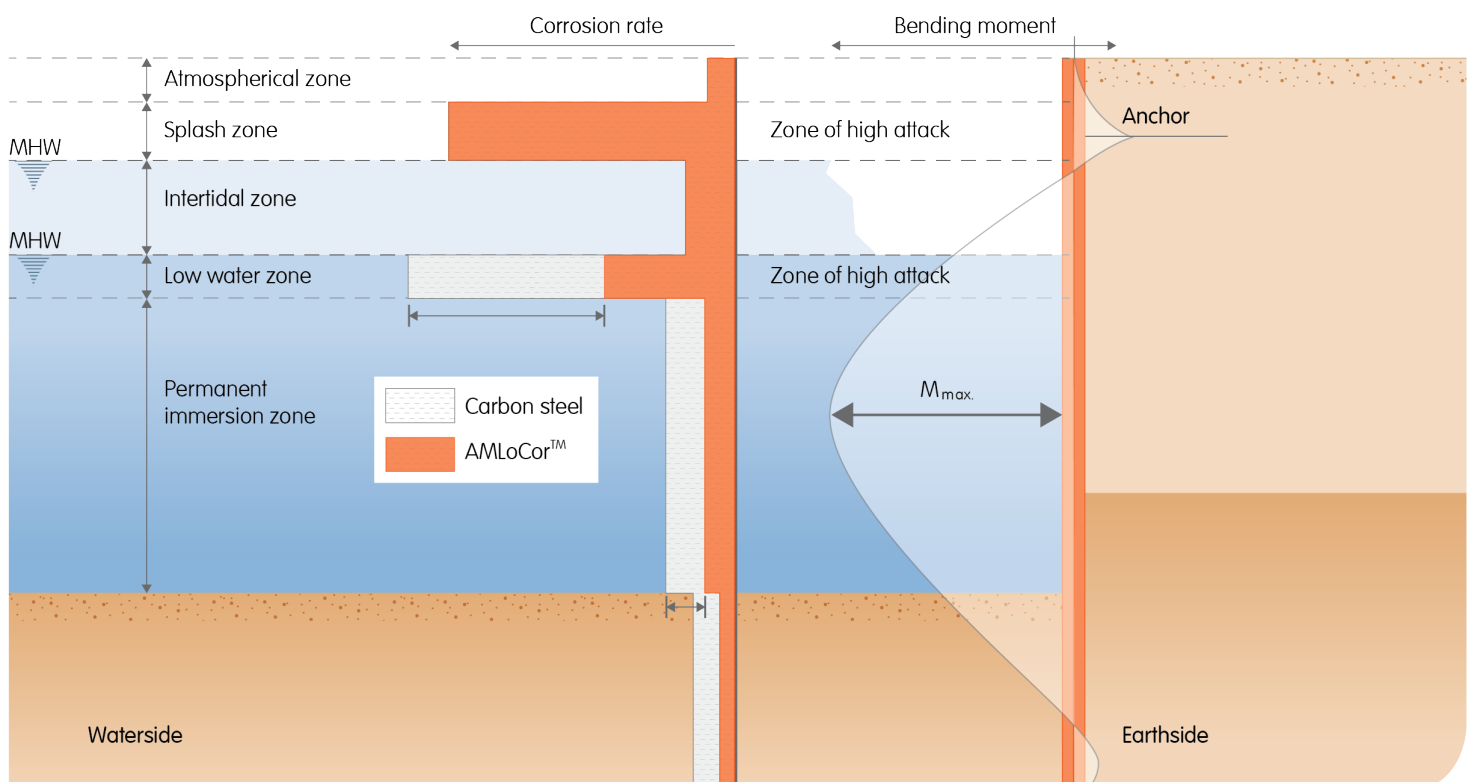

Coating systems

Unprotected steel in the atmosphere, in water and in soil is subject to corrosion. To mitigate the corrosion effect, steel structures can be protected with a coating to lower the corrosion rates during the required service life of the structure. More information on coating systems can be found in the European standard EN ISO 12944. According to EN ISO 12944 the corrosivity categories listed in the table below can be defined depending on the surrounding environment.

When applying a coating system, the steel surface needs to be cleaned in order to achieve sufficient bonding between the coating layers and the steel structure. Depending on the application and durability, different blast cleaning categories are defined based on how thorough the surface needs to be cleaned. For foundation applications Sa 2½ is commonly used.

Atmospheric corrosivity categories

Corrosivity category	Amount of corrosiveness	Examples
C1	Very low	Atmospheres with very low levels of pollution.
C2	Low	Atmospheres with low levels of pollution. Mostly rural areas.
C3	Medium	Urban and industrial atmospheres, moderate sulfur dioxide pollution. Coastal areas with low salinity.
C4	High	Industrial areas and coastal areas with moderate levels of salinity.
C5-I (Industrial)	Very high	Environment where high concentrations of sulfur dioxide (SO ₂) are present that will settle on steel surfaces
C5-M (Marine)	Very high	Steel structures that are exposed to fine particles of sea mist that will settle as salt crystals on the surface.

Corrosivity categories in water and soil

Category	Environment	Examples
Im1	Fresh water	River installations, hydro-electric power plants
Im2	Sea or brackish water	Harbour areas with structures like sluice gates, locks, jetties, offshore structures
Im3	Soil	Buried tanks, steel sheet piles, steel tubes

Blast cleaning methods

Category	Cleaning methods
Sa 1	Light blast cleaning
Sa 2	Thorough blast cleaning
Sa 2½	Very thorough blast cleaning



Coated tubes for tubular combined wall system (Project Wandelaarskaai, Belgium)



Coated tubes on transport

In a coating system two main layers can be distinguished:

1. Primer coating layer

The primer is the first coating layer of the protection system. This layer functions as the adhesion layer to roughened and cleaned metal, ensuring that there is a sound base for subsequent coating layers.

2. Top coating layers

Additional layers provide the final protection of the coating system. Below three commonly used examples are given for a coating system in the atmospheric conditions C4 and C5-M and the immersion condition Im 2.

Corrosivity category C4:

(EN ISO 12944 – table A4)

Epoxy primer (80µm)

Modified epoxy (280µm)

Nominal dry film thickness of the system: 360µm

Corrosivity category C5-M:

(EN ISO 12944 – table A5)

Epoxy primer (80µm)

Modified epoxy top coat (320µm)

Nominal dry film thickness of the system: 400µm

Corrosivity category Im 2:

(EN ISO 12944 – table A6)

Epoxy primer (80µm)

Modified epoxy top coat (500µm)

Nominal dry film thickness of the system: 580µm

Cathodic protection

Two different types of cathodic protection to stabilize corrosion of steel exist; passive and active cathodic protection.

Passive cathodic protection

Sacrificial anodes of a less noble metal (e.g. aluminium or zinc) are introduced in the system which dissolves instead of the steel in the tubular combined wall.

In case of aluminium anodes the following reaction replaces the steel degradation reaction as stated on page 20.



Active cathodic protection

An impressed current supplies additional electrons to the steel structure, so that the positive metal ions are “electrically bound”. Therefore it is no longer possible for the positively charged metal ions to go into the solution.

Instead of the regular anodic reaction (as stated in page 20), now a cathodic reduction of the diffusing oxygen takes place. The entire surface of the metal structure has become a corrosive impregnable cathode.



Capping beam

For protection purposes also a capping beam could be engineered as protection against corrosion. This capping beam acts as a protective skirt in the intertidal and splash zone.

Concrete capping beam in Amazonehaven, the Netherlands



Optimization

In the search for the most economical solution, a further optimization of the tubular combined wall is a key element in the engineering process. Our engineering department is specialized in project optimizations, leading to more economical total solutions. When optimizing the combined walls, alternatives should be compared based on the characteristics of moment of inertia and bending moment capacity.

Project optimization

With our free engineering services we look for the most optimal solution for your project. The optimization will be tailor-made for the project, whether the starting point is of mechanical nature (strength/stiffness), a quick start of the works is requested and/or fast consecutive deliveries of tubes are required. Foundation Solutions always tries to fulfil the customer's expectations by using its wide variety of possibilities;

- producing tubes in the spiral mill from coils
- quick and economical deliveries using stock material
- various tube production locations all over the world
- largest range of possible intermediate sheet piles
- reduce number of systems by using wider sheet piles
- full hands on logistical and quality control services

Depending on the location and specification of the project, a combination of the possibilities above can be made, even if the initial solution does not match our product range. Additional production on the tubes (like welding interlocks, stiffening plates, rock shoes, rings, etc.) can be done in one of our welding shops.

Change tube dimensions based on the production process

Tubes can be produced using several different production processes. The two most common production methods are spirally welded and longitudinally welded. Due to the worldwide availability of coils it is possible to produce spirally welded tubes up to a thickness of 28 mm in X70. Where thicker tubes are required, one would need to consider longitudinally welded tubes. The costs of longitudinally welded tubes are much higher because of the expensive production process and base material costs. By altering the design into dimensions which could be produced in spirally welded tubes, the total costs could be reduced even if this would lead to a higher tonnage.

Reducing the weight

The costs of the steel structure are often measured by its weight. By reducing the weight of the total structure the costs can be reduced. As the tubes form the heaviest part of the tubular combined wall, the optimization is often focused on the tubes.

Tubes from stock

Besides the production facilities for making spirally welded tubes, Foundation Solutions has a large stock of tubes at its disposal to be used for projects all around the world. In general, the cost prices of these stock tubes are lower than newly produced tubes. The wide range of stock tubes allows Foundation Solutions to deliver the material quickly so that the client could start his work early.



Coils on stock and coated tubes

Installation guide

General

The installation of the tubular combined wall requires detailed attention to the equipment and the manner of installation. It is advised to use a crane with a leader or to utilize a two level driving template. The supplementary equipment required depends on whether the installation will be done from water or land.

For installing the tubular combined wall from water either a pontoon or a jacket structure is needed for the crane. An additional pontoon or barge can be attached to the main structure for the supply of tubes and sheet piles.

When installing a tubular combined wall, the tubes should always be placed first by using a driving template because these are the stiffest elements. The more flexible intermediate sheet piles should be installed afterwards.



Installation of a tubular combined wall from water

Driving templates

In order to fix the position of the tube in the horizontal direction a driving template is required. A typical configuration of a driving template is shown in the figure below. Templates are usually constructed with beams and/or hollow sections. The short cross beams are placed in such a way that the right distance between the tubes can be assured. Welded onto the cross beams, are small "notches" to hold the interlock in place and to prevent the rotation of the tubes while driving. The space between the interlocks and the notches should not be more than a few millimetres.

A template should always have an odd number of spaces for the tubes. Depending on the diameter of the piles, this number can be either 5 or 7. This number is important for the installation sequence of the tubes, which will be explained later on in this chapter.



Flexible interlock notches and tube guiders

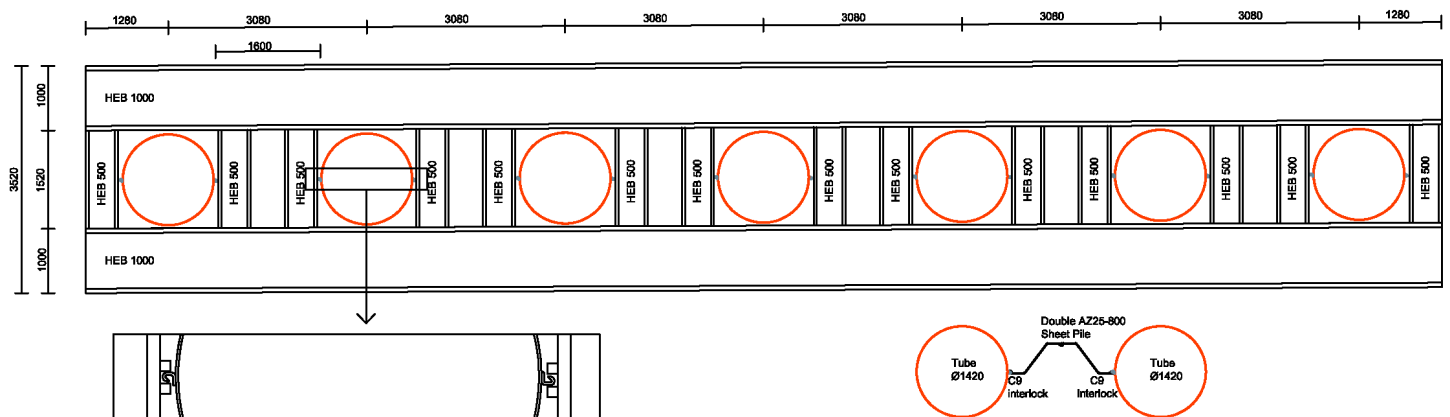

Schematic drawing driving template

Two main types of driving templates exist: Single and double level. The most common is the single level template, however in certain cases a double level template can be used to ensure that the tubes are installed within the vertical tolerances. For driving tubes from water a floating or non-floating template can be used. Foundation Solutions has the capability to design and produce project specific driving templates on demand of the customer.

Single level template

Single level templates are widely used to drive the sheet piles and tubes. This type of template does not give any vertical guidance during the installation of the tubes. The vertical guidance should be derived from a leader on the crane and by good guidance of the ground crew and the crane driver. To ascertain the exact verticality of the tubes, constant monitoring by two total stations or theodolites can be an option. These measurement devices have to be placed in line with the tubes perpendicular to each other.

On land the templates are directly placed on the ground. But for installation from water two options are possible.

A floating template. Care needs to be taken to stabilize and fix this structure in a horizontal way. This type of template can only be used in calm waters.



A non-floating template. The template rests on either auxiliary or already installed tubes of the combined wall. This type of template is more stable and can be used in more rough waters.



Double level template

A double level template provides stability and good guidance in both the horizontal position as well as the verticality of the piles. This type of template is normally fixed by external piles, which need to be driven separately. These piles will keep the frame in the correct position during installation of the bearing elements. There is no need for additional monitoring with a total station to ascertain the position of the piles with a double template.

Often it is required to remove the template before the tubes can be driven to the final depth.



Double level driving template

The order of installation

The order of installation is important to guarantee the best possible results regarding the horizontal positioning of the tubes and their verticality. The sequence of installation is depicted by the numbers in the figure below.

The reason for installing the piles in this order is geotechnical. When installing a tube the surrounding soil is compacted. If you install the tubes from left to right, the sub-strata will be compacted in this order, which can lead to non-verticality of the adjacent installed tube. By keeping the order of installation as advised, the level of compaction of the sub-strata is similar on both sides of each tube as it is driven.

After the installation of seven piles the template can be moved to the last pile on the right. This pile will act as the first pile for the following section.

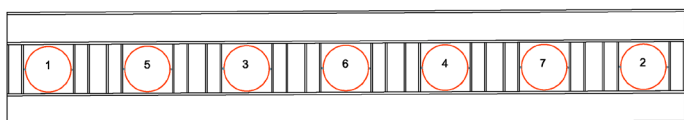

Installation sequence

Tolerances

Depending on soil conditions, length, shape and size of the intermediate sheet piles, the tolerances on the position of the pile top and verticality are usually very strict. These tolerances should be established and agreed upon in each case in order to ensure that declutching is not likely to occur.

- According to the Dutch guideline 'CUR166 Damwandconstructies', it is recommended that the verticality stays within 10mm/m length of the tube. In some occasions a stricter tolerance of 2 - 5mm/m is required.
- With regards to the horizontal tolerances, the tubes need to be within 10 to 15mm of the center line of the tubular combined wall.

Intermediate sheet piles

Installation of intermediate sheet piles should always take place after installation of the tubes. The already installed tubes will act as guiders for the sheet piles. As the intermediate sheet piles are more flexible than the tubes, they can follow small imperfections in the verticality of the tubes while remaining clutched.

Depending on the soil conditions, pre-drilling of the sheet piles can be considered. The intermediate sheet piles will be less likely to be overstressed if correct pre-drilling has been undertaken. Ease and speed of installation should be the main factor in determining how the intermediate sheet piles are installed.

Installed tubular combined wall from the water, Nieuwpoort — Belgium
© Werf Stormvloedkering Nieuwpoort — THV Herbosch-Kiere — Jan De Nul



Driving equipment

Current driving technologies allow the use of impact or vibratory hammers to drive tubes and intermediate sheet piles. Use of a vibratory hammer for installation can reduce the risk of damage. In hard soil conditions it is not always possible to install the tubes and sheet piles to the required depth using vibratory methods, so an impact hammer may be necessary.

A combination of the two techniques can also be used. Then the tubes are driven using a vibratory hammer till refusal, after which the final depth can be reached with an impact hammer. This combination of methods is also used when a plugging effect is required to increase the tip resistance of the tubes (as stated on page 18).

Vibratory hammers should be fitted with adequate clamps to ensure a correct load transfer to the pile. For intermediate AZ sheet piles double clamps are preferred. It is advisable to choose a vibratory hammer with sufficient weight and power to allow good driving speed and penetration while preventing damage to the interlocks caused by overheating.

Different types of impact hammers exist such as free-fall, diesel and hydraulic hammers. A driving cap must be used with free-fall or diesel hammers. In the case of an hydraulic hammer the manufacturer can provide special driving plates which fit the geometry of the pile head.

If the driving shows no progress or can only be achieved through excessive driving energy, a possible solution is to apply driving aids.



Vibratory hammer



Impact hammer

Driving aids

In this section the different driving aids are discussed that could assist the installation of a tubular combined wall. Also possible options for ensuring the interlocking of the system are mentioned.

Predrilling

Loosening cohesive and non-cohesive soil by drilling holes in the ground with an auger. This will reduce point resistance and shaft friction during installation. Less energy is needed to install the piles into the ground, leading to less vibrations.

Waterjetting

With waterjetting low water discharges are released under high pressure (10–20 bar) underneath the toe of the pile. This will reduce the toe resistance of the pile in non-cohesive soils. The ascending water lubricates the shaft, reducing the shaft friction. This technique is not to be confused with flushing, which uses high amounts of water with low pressures. More information about waterjetting can be found in our brochure “[Jetting-assisted sheet pile driving](#)”.



Toe of sheet pile with waterjetting in action.

Hybrid solutions

When only very limited vibrations are allowed during installation it is possible to go for a hybrid solution. The combined wall can be placed in a cement/bentonite- or soil mix wall. The combined wall can be lowered (without vibration) in the slurry trench and will act as the stiff structural element of this hybrid construction.

Driving shoe

In hard driving conditions other than rock soils, the tip of the piles can be reinforced using driving shoes. The design of these driving shoes varies greatly depending mainly on the type of soil, dimensions of the tubes and the driving equipment.

Often a driving shoe consists of ring welded on the inside of the tube. In clayey soils the ring and the end of the tube will be beveled in order to facilitate penetration of the clay. These driving shoes can also be applied to reduce cohesion of the clay on the inside of the tube.



Rock shoe

A rock shoe is a steel tip attached to the bottom of the tube in order to drive it into moraine or rock soil. The steel tip is equipped with a hole in which a drill can be installed to cut through the rock. This leads to easier installation of the tubes.



Declutching systems

The tubular combined wall system is designed in such a way that it behaves as an uninterrupted system. However, in some occasions sheet piles could declutch from the tube during installation. This might occur as a result of hard driving conditions or obstacles in the soil. Declutching detectors can be used to ascertain whether sheet piles have remained interlocked over their entire length during installation.

In general, two methods are used:

- Continuous detection over the total sheet pile length (inductive proximity sensor)
- Discontinuous detection at the bottom of the sheet pile (Dixeran system)

Continuous sheet pile detection

A sensor is placed through a hole in the interlock at the bottom section of the sheet pile. A continuous detection over the total sheet pile length will take place, according to the inductive proximity sensor principle. This sensor is protected by a steel box welded to the sheet pile. During installation the sensor sends a signal through an electrical cable to the monitoring unit at the surface as long as the interlocks are connected. When the interlocks declutch, the signal is disrupted and an error will occur on the control panel.



Discontinuous sheet pile detection (Dixeran)

In case of a discontinuous system only a signal will be given when the sheet pile reaches the required depth in the interlock. One of the systems which can be used is ArcelorMittal's Dixeran system, whereby an easily weldable shear sensor protrudes into the interlock on the tube.

If the intermediate sheet pile shears off the protruding sensor pin or causes a short circuit by deforming it, the sensor sends a different signal through an electrical cable to the monitoring unit at the surface.

This compact measuring instrument also detects and shows on its LED display other failures such as breakages, short-circuits in the power supply cable and proper operation of the shear sensor in both its intact and sheared state.

Although detectors do not prevent the occasional sheet pile from declutching, it is important to know whether sheet piles are properly connected to the tubes. When no change in signal is given after driving the sheet pile to the final depth, declutching has occurred and then it can be decided which measures need to be taken.

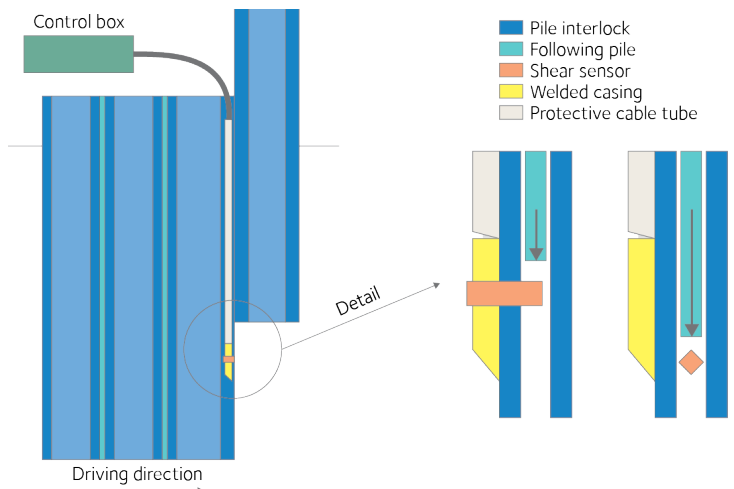

Schematic view of operating principle

Interlock guiders

In order to ease the installation of the intermediate sheet piles, interlock guiders can be used. These guiders consist of steel plates welded on the interlocks at the bottom of the sheet piles (see figure below).

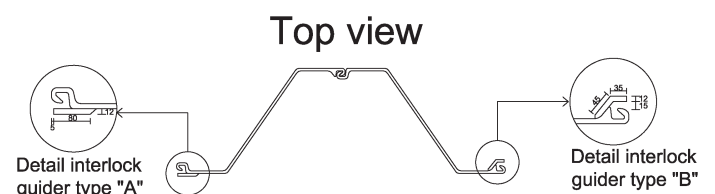

Anchoring system

Tie back system

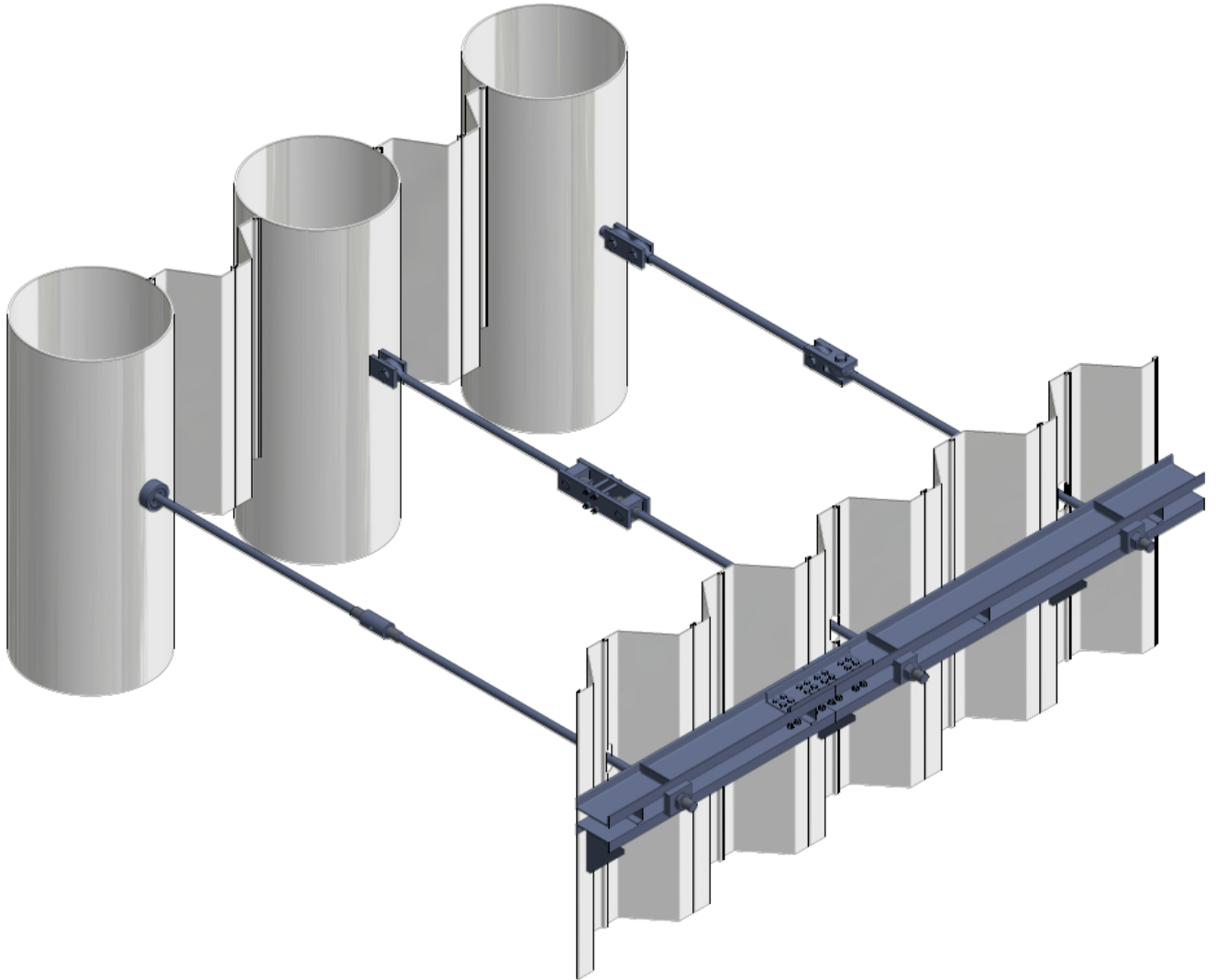

Anchoring a tubular combined wall using a tie back system can be quite simple and efficient. A tie rod links each tube to an anchor wall, which can consist of a sheet pile wall, steel tubes or even another combined wall.

The tie rod is fixed to the tube itself, therefore a traditional waling system can be avoided at the combined wall section. Above the features of the tie back system can be seen.

According to EN1993-5 consideration should be taken for both the **Serviceability** and **Ultimate Limit States**. The sizing of the tie rods also takes into account the resistance of the section at both the threaded and shaft sections of the tie rod once corrosion has been considered.



Installation of tie back system

Ultimate limit state

The tensile resistance $F_{(t,Rd)}$ of anchors should be taken as the lesser of $F_{(tt,Rd)}$ and $F_{(tg,Rd)}$. The tensile resistance $F_{(tt,Rd)}$ of the threaded section of the tie rod can be calculated with:

$$F_{tt,Rd} = \frac{k_t \times f_{ua} \times A_s}{\gamma_{m2}}$$

The tensile resistance of the shaft can be calculated with:

$$F_{tg,Rd} = \frac{f_y \times A_g}{\gamma_{m0}}$$

where:

$F_{tt,Rd}$	Tensile resistance of the threaded section	[kN]
k_t	Notch factor = reduction factor allowing for combined bending and tension in the thread. Recommended values of EN1993-5 are: $k_t = 0.6$ when bending at the connections must be considered $k_t = 0.9$ when structural detailing eliminates bending or combined stresses at the connections	
f_{ua}	Tensile strength of tie rod material	[N/mm ²]
A_s	Tensile stress area of thread	[mm ²]
γ_{m2}	Partial material safety factor 1.25 according to EN1993-5	
$F_{tg,Rd}$	Tensile resistance of shaft	[kN]
A_g	Gross cross-sectional area of tie rod	[mm ²]
f_y	Yield strength of tie rod material	[N/mm ²]
γ_{m0}	Partial material safety factor 1.0 according to EN1993-5	

Serviceability limit state

The cross-section of the tie rod shall be designed to provide sufficient resistance against deformations due to yielding of the tie rod under the characteristic load combination. This condition is satisfied when:

$$F_{t,ser} \leq \frac{f_y \times A_s}{\gamma_{mt,ser}}$$

where:

$F_{t,ser}$	Characteristic axial force of the anchor	[kN]
A_s	The lesser of minimum gross cross-sectional area of the shaft and tensile stress area of threaded section	[mm ²]
$\gamma_{mt,ser}$	Partial material safety 1.1 according to EN1993-5	

Installation of tie back system at Muuga Container Terminal



Injected anchor systems

Injected anchor piles can be used to limit the deflections of the tubular combined wall and/or to reduce the occurring bending moments.

Usually the anchoring system consists of a steel anchor that is placed under an angle with grout injection. The total load bearing capacity is highly dependent on the length of the grout body and the type of the soil. The shear resistance between the anchor, the grout body and the soil determines the allowable anchor force.

H / MV piles

Depending on the necessary tensile anchor force, H beams or tubes can be installed with or without grout injection. When these piles are grout injected, they are called MV piles (DE: Müller Verpresspfahl).

By enlarging the toe of the pile, a void is created in the soil during installation, which is progressively filled with grout. During installation the shaft friction is greatly reduced by this grout and so easing the installation process. After hardening the grout provides a better connection between the displaced soil and the MV pile and enables the mobilization of friction.

MV piles are normally installed with an impact hammer. The most efficient way of applying this anchor, is by installing it under 45 degrees. The method of driving H piles is shown in the picture below.

HP steel bearing piles are hot rolled H beams with the same flange and web thickness. In comparison to conventional HEB sections, HP piles feature a greater stability of shape during driving and a better weight/circumference ratio. More information can be found in the brochure 'HP Wide flange bearing piles'.



Example of a H beam equipped as MV pile



HEB beams

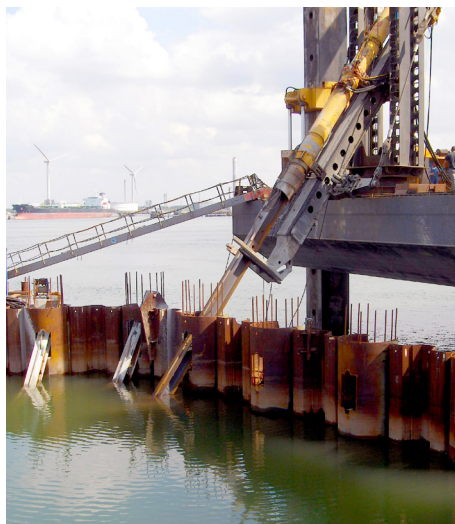

Installation of MV piles

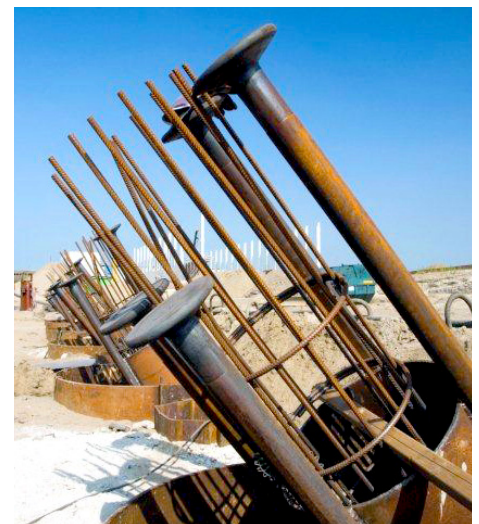

Example of a steel tube as anchoring element

Flap anchor

When the tubular combined wall is installed in water before any backfill has occurred, a flap anchor system can be a possibility. The fixed anchor consists of a H-pile with at the top side a hinge and at the bottom side an anchor plate (for example a sheet pile section).

The prefabricated anchor will be horizontally placed on the tube and rotated in a diagonal position before vibro-driving the anchor plate in the soil. Afterwards backfilling takes place on top of the anchor plate.

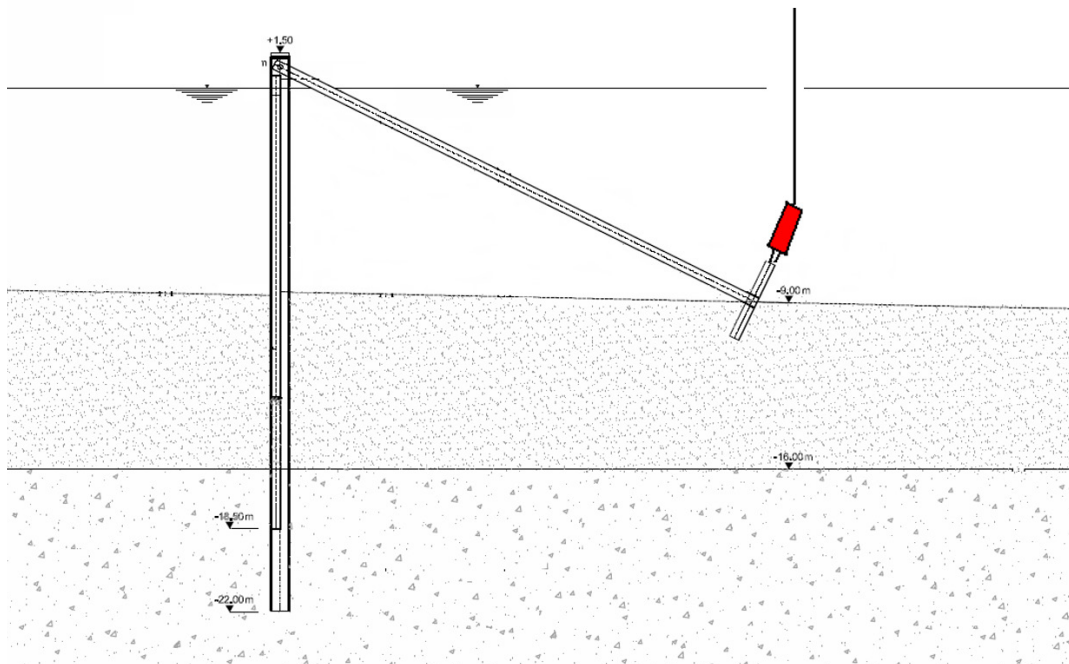

Vibro-driving of the anchor



Typical flap anchor end plate



Connection detail of flap anchor

Services

Logistics

As Foundation Solutions has a broad experience with both supply and transport, each project will get a tailor-made logistical solution.

Services

Foundation Solutions offers different services to the client including rental and buy back options for temporary structures. As well as our sheet pile and tubes sections, we offer all the supplementary parts of tubular combined walls, ranging from the waling system to the tie back system.

Foundation Solutions delivers the entire range of steel foundation products to its customers, and offers a total solution to its customers in civil engineering. In order to do so, Foundation Solutions relies on 3 pillars:

1. Extensive product range

Spirally welded tube mills with unique state-of-the-art tube production facilities. There is a large stock of steel coils available in order to achieve short delivery times.

Large stock of steel tubes:

- Newly produced, high quality tubes from excess production runs, mainly meant for gas transportation or water transmission pipelines.

Other tubes:

- If the customer's requirement is beyond our production range, we will rely on our worldwide network of tube producers, in order to find a technically and economically optimized solution for our customers. All external production activities will be done under ArcelorMittal's quality control.

2. Fabrication of end products

All our fabrication facilities have direct access to deep water which means we are able to deliver end products up to 120 ton per piece.

Our services include:

- Construction of tubes for the tubular combined walls (welding of clutches and welding tubes to required lengths), box piles, special sheet piles, MV piles
- Sealing of interlocks with: Beltan® Plus, Arcoseal™, Roxan® Plus, Akila® or by welding
- Coating: when end products need to be treated we can provide all requirements



3. Technical support

With our team of engineers we are able to find the most suitable solution for our customers by providing: feasibility studies, dimensioning of entire structures, elaboration of anchorage or strutting systems, calculation of vertical load-bearing capacity, et cetera. We can also provide driving plans. An example of an initial design is shown on the next page.

Quality Control

1. Certification

Projects Europe has been certified for many years for the production of spirally welded steel pipes. Our production facility is certified to produce spirally welded pipes according to customer requirements e.g.: EN 10219. Projects Europe has the right to issue 3.1. certificates with their products. 3.2. certificates can be issued when the production is controlled by a notified third party.

2. The quality process

Our quality management system is certified according to EN ISO 9001 (Lloyds Register Quality Assurance) to ensure a completely controlled process from purchasing the coils until delivery of the final goods to our clients. Furthermore, we hold a certification to produce under the CE MARK and the German DIN 18800 -7 (Grosser Eignungs Nachweiss).

Being a certified mill for spirally welded steel pipes the following quality conditions are guaranteed:

- Internal procedures for production of spirally welded pipes, and implementation of them in the production process
- Conformity of our procedures to EN 10219
- Methodology for testing and inspection in order to deliver quality products:
 - Purchase of base material with certificates of conformity as per the clients detail
 - Welding procedures and welders qualifications
 - Control on dimensioning
 - Visual inspection
 - Non-destructive inspection: the welds are 100% US tested
- Methodology for storage of end products
- Methodology for transport

ArcelorMittal Projects

ArcelorMittal

Design note

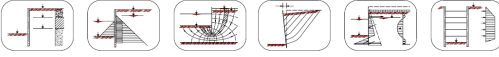

DESTINATION: Tubular combined wall brochure
REF. NO.:

PROJECT: Example calculation tubular combined wall

DESIGNER:

CHECKED BY:

DATE: **REVISION: 00**

PRELIMINARY

All the calculations, drawings and recommendations are part of our service to the customer but not part of our engagement by the contract.

Since these services do not form part of any contract between the partners, they are subject to verification by the customer. ArcelorMittal Projects is under no circumstances liable for any errors or mistakes.

ArcelorMittal Projects Europe
 Mannesmannweg 5
 4794 SL Heijningen
 P.O. Box 52
 4793 ZH Fijnaart
 The Netherlands

T +31 88 0083 700
 F +31 88 0083 800
 E. projects.europe@arcelormittal.com
 W www.arcelormittal.com/projects/Europe

ArcelorMittal

Design note

DESTINATION	Tubular Combined Wall Brochure	DATE		REV	00
PROJECT	Example Calculation Tubular Combined Wall	PAGE	2	RB	

Introduction

Subject: Global design for the construction of the quay wall at a harbor. The customer asked for an initial design of tubular combined wall structure.

Soil characteristics:
 The soil composition and characteristics are based on the information provided by the client.

Layer name	Level [m]	Unit weight		Cohesion [kN/m ²]	Friction angle phi [degrees]	Delta friction angle [degrees]
		Unsat [kN/m ³]	Sat [kN/m ³]			
Silty Sand	6,00	18,00	18,00	0,00	27,50	18,33
Very Soft Silty ...	2,80	15,00	17,00	0,00	22,50	15,00
Loose Sand	0,20	17,00	19,00	0,00	30,00	20,00
Very Soft Silty ...	-3,00	15,00	17,00	0,00	22,50	15,00
Dense Silty Sand	-5,00	19,00	20,00	0,00	32,50	20,00
Soft Silty Clay	-11,50	18,00	18,00	5,00	22,50	15,00
Med Dense Cla...	-19,00	19,00	21,00	0,00	30,00	20,00
Dense Sand	-21,00	19,00	21,00	0,00	35,00	23,33

Combined Wall
 The alternative tubular combined wall structure is tested for each construction phase.. The combined wall specification is

Tube $\varnothing 1420 \times 22$ L = 31.5 m X70
 Sheet pile AZ23 - 800 L = 24.0 m S430 GP

With an anchor wall with the following dimensions
 Sheet pile AZ23 - 800 L = 10.5 m S430 GP
 Anchor ASDO 500 - M80/60

This design note will show the calculations of the combined wall for the design conditions.

Remarks:

- Calculations have been done with the elastic spring model program DSheet.
- The structure is only modeled in elastic state; for the plastic state additional calculations are required.
- 2.0mm of corrosion is taken into account over the lifetime.
- Calculations are based on the principle of EC7 General Design Approach 2.
- Anchors have a length of approximately 30 m
- Anchor level is at +1 m CD
- There is a uniform load acting of the structure of 30 kN/m² during service conditions. A bollard load of 1500 kN per 20 meter length of quay is taken into account (75 kN/m).
- The resulting anchor force on the anchor wall is 920 kN/m.

ArcelorMittal

Design note

DESTINATION	Tubular Combined Wall Brochure	DATE		REV	00
PROJECT	Example Calculation Tubular Combined Wall	PAGE	3	RB	

Combined Wall Specification

Tube $\varnothing 1420 \times 22$ L = 31.5 m X70
 Sheet pile AZ23 - 800 L = 24.0 m S430 GP

Specification	
Combiwall - pile	$\varnothing 1420$ mm x 22.0 mm
Corrosion pile (after life-cycle)	2.0 mm
Length pile	31.5 m
Steelgrade pile	X70
Steel Sheet Pile	2 x AZ23-800
Length SSP	24 m
Section modulus combiwall	10.295 cm ³ /m
Moment of inertia combiwall	730.939 cm ⁴ /m
Bending moment capacity	4.993 kNm/m
System width	3.070 m
Weight per m ²	297 kg/m ²

Overview Service Conditions

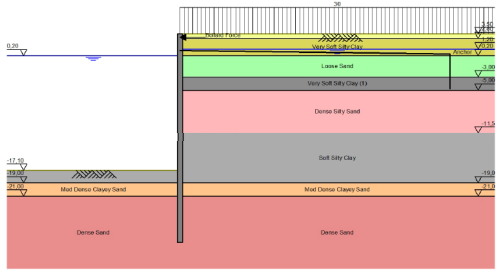

ArcelorMittal

Design note

DESTINATION	Tubular Combined Wall Brochure	DATE		REV	00
PROJECT	Example Calculation Tubular Combined Wall	PAGE	4	RB	

Results of Computation

Stage nr.	Verification type	Displacement [mm]	Moment [kNm]	Shear force [kN]	Mob. per. moment [%]	Mob. perc. resistance [%]
7	Deformation	-144,0	-2730,68	-704,82	50,1	53,7
7	DA 2	-3992,58	-963,80	54,1	57,4	
Max		-144,0	-3992,58	-963,80	54,1	57,4

Moments/Forces/Displacements - Stage 7: Phase 6
 DA 2 - Partial factor set: DA 2

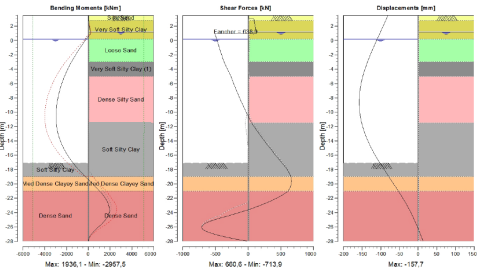

Unity Check
 An unity check calculation is made to show that the occurring bending moment can be overcome by the proposed tubular combined wall solution in combination with the steel grade. The Unity Check (U_c) should be smaller than 1.
 Required yield strength $G_{req} = M_{max} / W_{pl,y} = 3992.58 / 10.295 = 387.8$ MPa
 $U_c = G_{req} / G_{exis,pl} = 387.8 / 485 = 0.80 < 1$

Disclaimer: The information in this brochure has been compiled with the utmost care. Nevertheless, it is for general information purposes only. The use of the information is at the reader's risk. No warranty is implied or expressed by the Projects organization of ArcelorMittal with respect to the use of information this brochure contains. The information in this publication is subject to change or modification without notice. Please contact your regional office for the latest information. The images used in this brochure cannot be used for personal, non-commercial or commercial purposes.

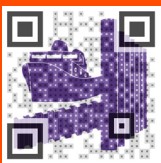

Projects Europe

T +31 88 0083 700 | projects.europe@arcelormittal.com | www.arcelormittal.com/foundationsolutions